

PRORAIL SYSTEM

PRORAIL SYSTEM SYSTEM is a modular system composed of aluminium joists to lay floating floors of any size, to create steady and modular substructures together with PROSUPPORT TUBE and PROSUPPORT SLIM. The system consists of two aluminium joists, PRORAIL and PRORAIL RET, one fastening ring PRORAIL RING, two cross spacers with removable flaps PRORAIL SPACER and one anti-noise and anti-slip rubber PRORAIL RUBBER

PRORAIL
PSTRAN 53

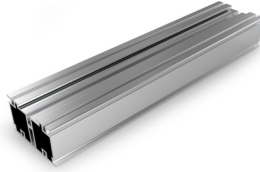
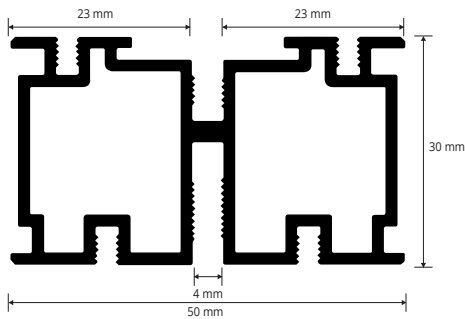

PRORAIL - SHAPED JOIST
aluminium - Pack 10 Pc - Bar length 2,7 Lm

Article	L x H (mm)	Pc/Pack		
PSTRAN 53	50 X 30	10		

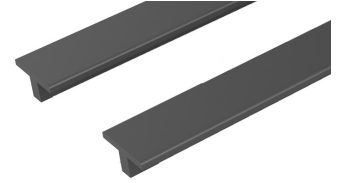

PRORAIL RUBBER - RUBBER INSERT
rubber - Roll length 110 ML

Article	L roll lm			
PSTRI	110			

PRORAIL RET
PSTRAN 5030

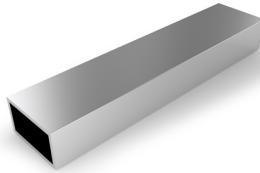
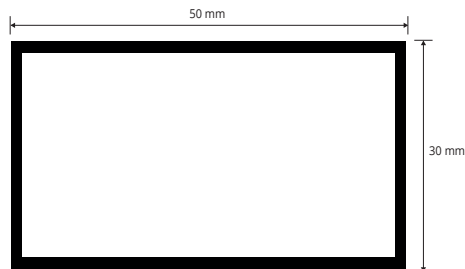

PRORAIL RET - SMOOTH JOIST
aluminium - Pack 10 Pc - Bar length 2,7 ML

Article	L x H (mm)	Pc/Pack		
PSTRAN 5030	50 X 30	10		



PRORAIL RING - JOIST FASTENING RING
polypropylene - Pack 40 Pc

Article	Ø mm	Pc/Pack		
PSTRR	135	40		

PRORAIL SYSTEM LAYING PATTERN

Material required for 1 qm of the below pattern:
-3 pcs PROSUPPORT TUBE/PROSUPPORT TUBE SLIM
-3 pcs fastening rings PRORAIL RING
-2.7 lm PRORAIL joist
-4 lm PRORAIL RUBBER

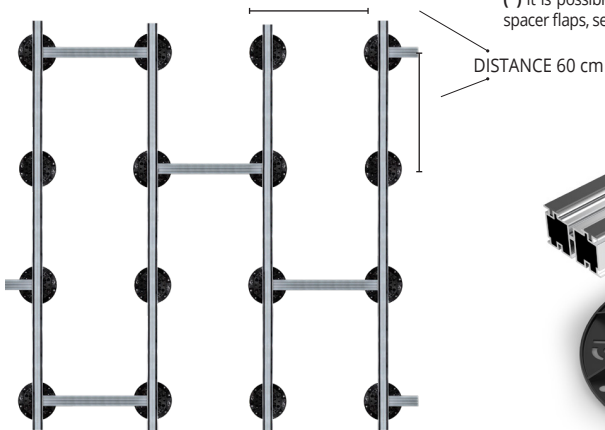

TECHINCAL LAYING INSTRUCTIONS

1. Choose the support PROSUPPORT TUBE or PROSUPPORT SLIM of the required height;
2. Set the fastening ring PRORAIL RING on the supports;
3. Set the joist PRORAIL (*) or the joist PRORAIL RET on the ring;
4. Insert the rubber PRORAIL RUBBER inside the grooves of the joist PRORAIL;
5. Set the cross spacers PRORAIL SPACER following the laying pattern; (*) It is possible to fix the joist PRORAIL on the supports fixing it into the spacer flaps, see picture hereunder.



PRORAIL SPACER
PSTRS 02



PRORAIL SPACER
PSTRS 04

PRORAIL SPACER - CROSS SPACER with removable flaps
polypropylene - Pack 100 Pc

Article	thickness (mm)	Pc/Pack		
PSTRS 02	2	100		
PSTRS 04	4	100		

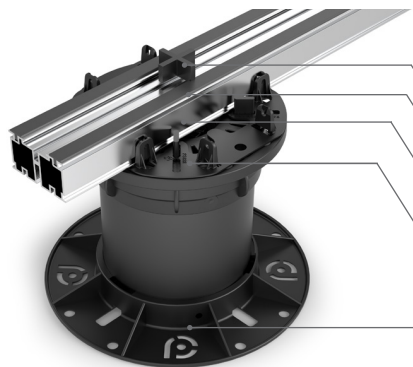

- PRORAIL SPACER - PSTRS 02/04
- PRORAIL RUBBER - PSTRI
- PRORAIL - PSTRAN 53
- PRORAIL RING - PSTRR
- PROSUPPORT TUBE

FIXING WITH PRORAIL JOIST:

Prosupport tube/slim + Prorail + Prorail spacer + Prorail rubber



FIXING WITH RING AND PRORAIL JOIST:

Prosupport tube/slim + Prorail ring + Prorail + Prorail spacer + Prorail rubber



FIXING WITH RING AND PRORAIL RET SMOOTH JOIST :

Prosupport tube/slim + Prorail ring + Prorail ret

